

Dental Electrical Motors

USERS GUIDE

C-PUMA

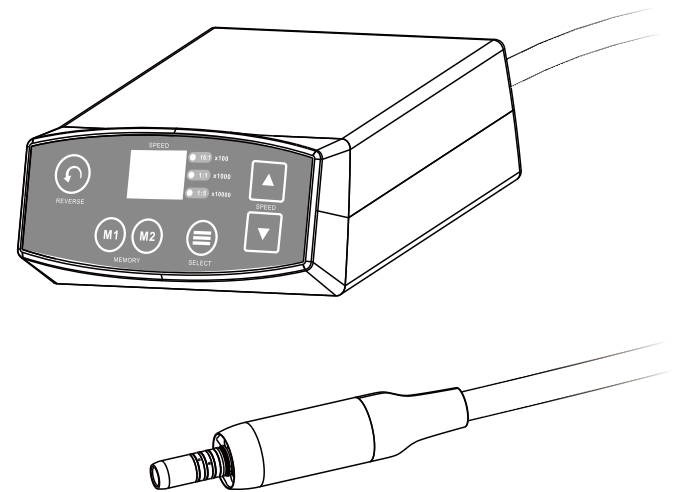

Foshan COXO Medical Instrument Co.,Ltd

BLDG4, District A Guangdong New Light Source Industrial Base South of Luocun Avenue
Nanhai District Foshan 528226 Guangdong China.



Lotus NLB.V.

Koningin Julianaplein 10, 1e Verd, 2595AA, The Hague, Netherlands.

E-mail: peter@lotusnl.com

Ver 1.6 Revision Date: 2022-01-14

COXO[®]

CE₀₁₉₇

Thank you for purchasing the COXO C-PUMA dental electrical motor.
 We recommend that prior to use, you read this document carefully regarding instructions for using, handling method, or maintenance check so that you can carry on using the unit in the future.

In addition, please keep this operation manual in a place where a user can refer to it at any given time.

◆ Classification of equipment

- Type of protection against electric shock :
 - Class I equipment
- Degree of protection against electric shock :
 - Type B applied part 
- Method of sterilization or disinfection recommended by the manufacture :
 - See 7. Cleaning, disinfection, packing and sterilization
- Duty cycle(ON 40 sec/OFF 10 min)
 - The electric motor is designed for intermittent operating mode with an operating time of 40 seconds and an idle time of 10 minutes. If the operating mode specified is observed no overheating of the system and therefore no injury to the patient, user or third persons arises.
 - Not to position the ME equipment so that it is difficult to operate the disconnection device.

Indications:

- This product is suitable for oral repair of patients such as: tooth decay, tooth restoration, periodontal disease.



Contraindications:

Patients with implanted pacemakers were fitted.

 Cautions for operation

- Read these safety cautions thoroughly before use and operate the product properly.
- These indicators are to allow you to use the product safely, prevent danger and harm to you and others.

These are classified by degree of danger, damage and seriousness. All indicators concern safety, be sure to follow them.

Classification	Degree of Danger or Damage and Seriousness
 Attention	Explains an instruction where personal injury or physical damage may occur.
 CAUTION	Explains an instruction where minor to medium injury or physical damage may occur.
 NOTICE	Explains an instruction that should be observed for safety reasons.

Recommended separation distances between portable and mobile RF communications equipment and the C-PUMA

The C-PUMA is intended for use in an electromagnetic environment in which radiated RF disturbances are controlled. The customer or the user of the C-PUMA can help prevent electromagnetic interference by maintaining a minimum distance between portable and mobile RF communications equipment (transmitters) and the C-PUMA as recommended below, according to the maximum output power of the communications equipment.

Rated maximum output power of transmitter (W)	Separation distance according to frequency of transmitter		
	150 kHz to 80MHz $d=1.2 \times P^{1/2}$	80MHz to 800MHz $d=1.2 \times P^{1/2}$	800MHz to 2.5GHz $d=2.3 \times P^{1/2}$
0.01	0.12	0.12	0.23
0.1	0.38	0.38	0.73
1	1.2	1.2	2.3
10	3.8	3.8	7.3
100	12	12	23

For transmitters rated at a maximum output power not listed above, the recommended separation distance d in metres (m) can be estimated using the equation applicable to the frequency of the transmitter, where P is the maximum output power rating of the transmitter in watts (W) according to the transmitter manufacturer.

NOTE 1 At 80 MHz and 800 MHz, the separation distance for the higher frequency range applies.
NOTE 2 These guidelines may not apply in all situations. Electromagnetic propagation is affected by absorption and reflection from structures, objects and people.

Safety Caution



WARNING:
Please read the following information completely before use this product.

1. This unit must be used as the user's guide mentions, not for other purpose.
Please refer to the usage instruction strictly. We won't take the responsibility for the damage caused by improper use.
2. Before using the main power, make sure the power voltage is according to adaptor voltage range. Improper input voltage will damage the unit and cause danger to operator or patient.
3. Please use the original accessories, such as: motor handle and adaptor.
We won't take the responsibility to any problem or damage caused by using other parts which are not supplied by us.
4. To avoid electric shock, don't insert any other parts into the unit; it may cause electric shock or damage.
5. When you install control box or motor, do not twist the tubing or the cord.
6. Avoid the detergent go into the unit, in case that causes the short circuit or problem.
7. Please turn off the instrument at once when something wrong with it.
It's not allowed to modify the unit at any condition. Any disassembling or modification will cause the invalidation of the guarantee.
8. Turn off the power switch after each use. If unit is to be stored for long periods of time, drain water from unit and hose.
9. Protect the instrument from ambient electromagnetic interference.
When there is a patient who is using the cardiac pacemaker, or there is an electronic operation, please don't put the machine around.
10. Unstable voltage and being under electromagnetic environment will interfere with the normal operation.
11. This unit is just for the professional user.

Standard Configuration

Control box(with motor handle)	1
Adaptor	1
Power cord	1
U-shaped bracket (optional)	1
L-shaped bracket (optional)	1
Hand screw(accessories of bracket)	2
Screw and nut(accessories of bracket)	4
Seal ring	9
Axial plug pump	1
Motor Cap	1
User manual	1

Intended Use

This product is used for cutting / polishing of the tooth, and it provides only to the dentists who have already been trained and use only in clinic and laboratory.

Construction and Installation

Standard Components



L-shaped bracket

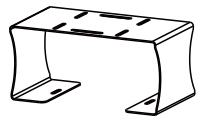

U-shaped bracket

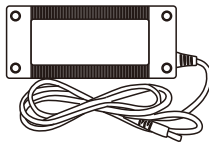

Adaptor



Power cord



Handpiece stand

Guidance and manufacture's declaration – electromagnetic immunity			
The C-PUMA is intended for use in the electromagnetic environment specified below. The customer or the user of C-PUMA should assure that it is used in such an environment.			
Immunity test	IEC 60601 test level	Compliance level	Electromagnetic environment - guidance
Conducted RF IEC 61000-4-6	3 Vrms 150 kHz to 80 MHz 6 Vrms in ISM band 3 V/m 80 MHz to 2.7 GHz	3 Vrms 150 kHz to 80 MHz 6 Vrms in ISM bands	Portable and mobile RF communications equipment should be used no closer to any part of the C-PUMA, including cables, than the recommended separation distance calculated from the equation applicable to the frequency of the transmitter.
Radiated RF IEC 61000-4-3	385MHz- 5785MHz Test specifications for ENCLOSURE PORT IMMUNITY to RF wireless communication equipment (Refer to table 9 of IEC 60601-1- 2:2014)	3 V/m 80 MHz to 2.7GHz 385MHz- 5785MHz Test specifications for ENCLOSURE PORT IMMUNITY to RF wireless communication equipment (Refer to table 9 of IEC 60601-1- 2:2014)	Recommended separation distance $d=1.2 \times P^{1/2}$ $d=1.2 \times P^{1/2}$ 80 MHz to 800 MHz $d=2.3 \times P^{1/2}$ 800 MHz to 2,5 GHz where P is the maximum output power rating of the transmitter in watts (W) according to the transmitter manufacturer and d is the recommended separation distance in meters (m). Field strengths from fixed RF transmitters, as determined by an electromagnetic site survey, ^a should be less than the compliance level in each frequency range. ^a Interference may occur in the vicinity of equipment marked with the following symbol: 
NOTE 1 U_i is the a.c. mains voltage prior to application of the test level. NOTE 2 At 80 MHz and 800 MHz, the higher frequency range applies. NOTE 3 These guidelines may not apply in all situations. Electromagnetic propagation is affected by absorption and reflection from structures, objects and people.			
a. Field strengths from fixed transmitters, such as base stations for radio (cellular/cordless) telephones and land mobile radios, amateur radio, AM and FM radio broadcast and TV broadcast cannot be predicted theoretically with accuracy. To assess the electromagnetic environment due to fixed RF transmitters, an electromagnetic site survey should be considered. If the measured field strength in the location in which the C-PUMA is used exceeds the applicable RF compliance level above, the C-PUMA should be observed to verify normal operation. If abnormal performance is observed, additional measures may be necessary, such as re-orienting or relocating the C-PUMA. b. Over the frequency range 150 kHz to 80 MHz, field strengths should be less than 3 V/m.			

Guidance and manufacture's declaration – electromagnetic immunity			
The C-PUMA is intended for use in the electromagnetic environment specified below. The customer or the user of C-PUMA should assure that it is used in such an environment.			
Immunity test	IEC 60601 test level	Compliance level	Electromagnetic environment - guidance
Electrostatic discharge (ESD) IEC 61000-4-2	±8 kV contact ±2 kV, ±4 kV, ±8 kV, ±15 kV	±8 kV contact ±2 kV, ±4 kV, ±8 kV, ±15 kV air	Floors should be wood, concrete or ceramic tile. If floor are covered with synthetic material, the relative humidity should be at least 30%.
Electrical fast transient/burst IEC 61000-4-4	±2kV for power supply lines ±1 kV for Input/output lines	±2kV for power supply lines ±1 kV for Input/output lines	Mains power quality should be that of a typical commercial or hospital environment.
Surge IEC 61000-4-5	±0.5 kV & ±1 kV differential mode ±0.5 kV, ±1 kV & ±2 kV common mode	±0.5 kV & ±1 kV differential mode ±0.5 kV, ±1 kV & ±2 kV common mode	Mains power quality should be that of a typical commercial or hospital environment.
Voltage dips, short interruptions and voltage variations on power supply input lines IEC 61000-4-11	100 % U_T (100% dip in U_T .) for 0.5 cycle 100 % U_T (100% dip in U_T .) for 1 cycle 30 % U_T (70% dip in U_T .) for 25/30 cycles 100 % U_T (100% dip in U_T .) for 250/300 cycle	100 % U_T (100% dip in U_T .) for 0.5 cycle 100 % U_T (100% dip in U_T .) for 1 cycle 30 % U_T (70% dip in U_T .) for 25/30 cycles 100 % U_T (100% dip in U_T .) for 250/300 cycle	Mains power quality should be that of a typical commercial or hospital environment. If the user of the model C-PUMA requires continued operation during power mains interruptions, it is recommended that the model C-PUMA be powered from an uninterruptible power supply or a battery.
Power frequency (50/60 Hz) magnetic field IEC 61000-4-8	3A/m	3A/m	Power frequency magnetic fields should be at levels characteristic of a typical location in a typical commercial or hospital environment.
NOTE: U_T is the a.c. mains voltage prior to application of the test level.			

Structure

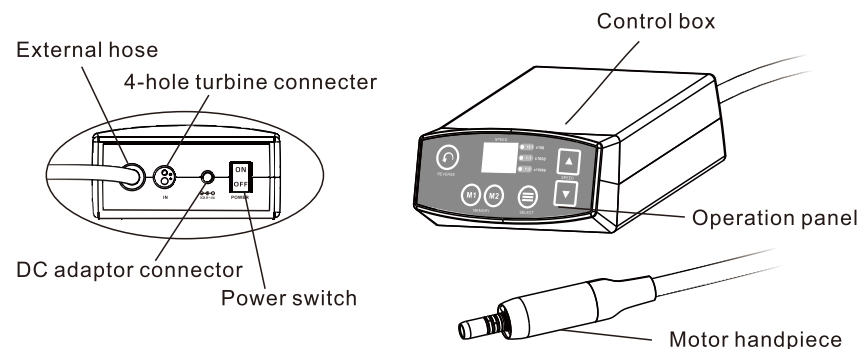

Operating control box

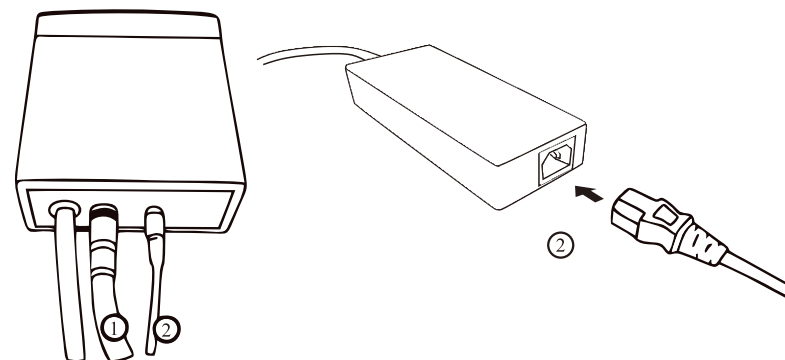

1. Connect the 4-hole turbine hose to the control box

Fit the 4-hole turbine hose to the 4-hole turbine connector of control box and tighten.

2. Connecting the DC adaptor and power cord

Insert the DC adaptor plug into the DC adaptor connector, and then use the power cord connect the plug and DC adapter.

⚠ Attention:

Before insert or pull out the power cord, make sure that the power switch in the closed position, in order to prevent electric shock.

Handling the motor

1. Connecting / disconnecting the motor and the motor cord

To remove the motor cord from the motor, unscrew and detach the motor cord nut, and gently pull out the motor cord connector.

To connect, align and insert firmly the pins of the connector carefully into the pin holes of the motor, and fasten the motor cord nut securely.

2. Connecting / disconnecting the motor and the handpiece attachments

Assemble the handpiece attachment by inserting the motor insert into the handpiece attachment, and turn attachment until it clicks and positioning pins are aligned.

Remove the handpiece by pulling the handpiece attachment out from the motor.

Install the bracket

L-shaped

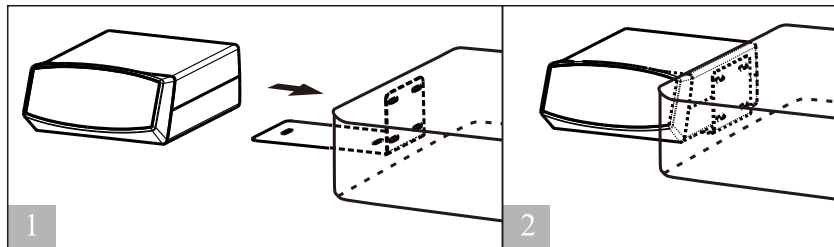

U-shaped

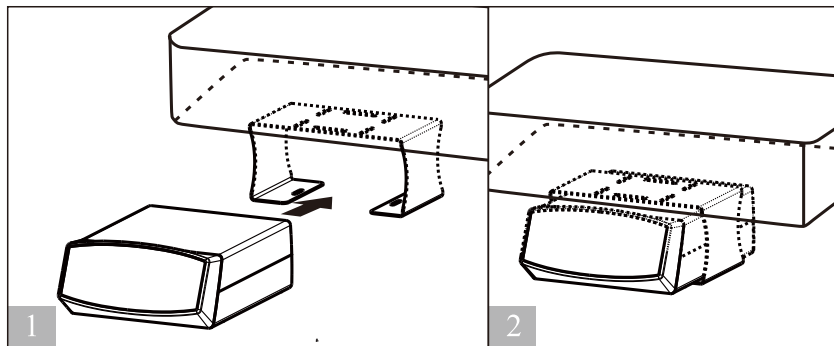

Guidance and Manufacturer's Declaration--EMC

This product needs special precautions regarding EMC and needs to be installed and put into service according to the EMC information provided, and this unit can be affected by portable and mobile RF communications equipment.

⚠ Caution:

- Do not use a mobile phone or other devices that emit electromagnetic fields, near the unit. This may result in incorrect operation of the unit.
- This unit has been thoroughly tested and inspected to assure proper performance and operation!
- This machine should not be used adjacent to or stacked with other equipment and that if adjacent or stacked use is necessary, this machine should be observed to verify normal operation in the configuration in which it will be used

Guidance and manufacture's declaration – electromagnetic emission		
The C-PUMA is intended for use in the electromagnetic environment specified below. The customer of the user of the C-PUMA should assure that it is used in such an environment.		
Emission test	Compliance	Electromagnetic environment – guidance
RF emissions CISPR 11	Group 1	The C-PUMA use RF energy only for its internal function. Therefore, its RF emissions are very low and are not likely to cause any interference in nearby electronic equipment.
RF emission CISPR 11	Class B	The C-PUMA is suitable for use in all establishments, including domestic establishments and those establishments directly connected to the public low-voltage power supply network with specific requirement.
Harmonic emissions IEC 61000-3-2	Class A	
Voltage fluctuations/ flicker emissions IEC 61000-3-3	Complies	

-  This way up
-  Fragile, handle with care
-  Keep dry
-  Special disposal of waste electrical and electronic equipment
-  Power On (power connection)
-  Power Off (power disconnection)
-  Serial number
-  Protect from heat and radioactive sources
-  Avoid the sun
-  Manufacturers
-  CE marked product
-  European Union agent

As shown in figure, when installing a L-shaped bracket, the fixed to the treatment of dental chair on the side, and in the corresponding position fixed screw; when installing a U-shaped bracket, the fixed to the treatment of dental chair under the table, and in the corresponding position fixed screw.

Function and Settings

General function

Power Switch Symbol Mark		○
Function	ON	OFF

Insert the power cord plug in AC outlet and turn on the power switch. When you turn on the power switch, lamps and speed indicator will be illuminated.

Handpiece Gear Ratio	Indicator	Speed (rpm)
16:1	1~25	100 - 2,500
1:1	2~40	2,000 - 40,000
1:5	1~20	10,000 - 200,000

Before using this system, make sure to perform foot air calibration function.

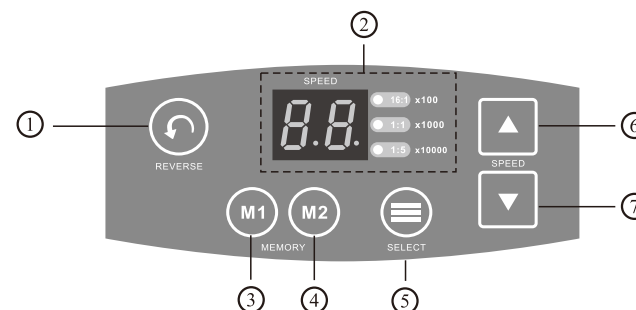

- ① Reverse key
- ② Display area
- ③ Memory 1 key
- ④ Memory 2 key
- ⑤ Gear ratio select key
- ⑥ Up key
- ⑦ Down key

1. Press the gear ratio select key ⑤ to select the gear ratio, and the corresponding indicator for the gear ratio will turn on.
2. The value of speed displays on display area ②, and adjust by pressing up key ⑥ and down key ⑦, the setting as follow:
Delay time to turn off the lights set pattern time value step 1 s, adjusting range 0 to 30;
16:1, show 1 to 25
(corresponding speed 125 RPM to 2500 RPM, step 100 RPM)
1:1, show 2 to 40
(corresponding speed 2000 RPM to 40000 RPM, step 1000 RPM)
1:5, show 1 to 20
(corresponding speed 10000 RPM to 200000 RPM, step 10000 RPM)
3. Select the direction of rotation using the reverse key ①.
4. Press the M 1 key ③ or M 2 key ④ to export the recorded program.
Hold the M 1 key ③ or M 2 key ④ (>3s) to save the program.
5. The micromotor operation is controlled by the air switch/foot pedal of the delivery unit.

Composite key setting

1. Press the reverse key ① first, and then at the same time hold the M2 key ④ (≥1 s) into the lights delay time out adjust mode, and adjust the value by pressing up key ⑥ and down key ⑦, short press reverse key ① out of the model.
2. Press the reverse key ① first, and then at the same time hold the down key ⑦ (≥1 s) manual open lamp, display area ② shows F1, short press the reverse key ① or after 30 s lights automatically turn off.
3. Press the reverse key ① first, and then at the same time hold the up key ⑥ and the down key ⑦ (≥1 s) to restore the factory settings.

Technical Services

1.Power adaptor:	Input: 100-240V~ 50/60Hz 2.5A Output: DC 29V/4A
2.Control box:	Input: DC 29V/4A Dimensions:D167xW134xH69mm
3.Motor:	Rotation speed:2,000-40,000 rpm Dimensions: Φ23xH83mm Cord length: 170 cm
4.Temperatures	Operating: +5°~+40°C Storage: -10°~+55°C
5.Humidity	Operating: 20-80%RH Storage: ≤93%RH
6.Atmospheric pressure	Operating: 86-106kPa Storage: 50-106kPa
7.Protection against electrical shock:	Type B

Symbol Definition



Warning



Type B applied part



Caution



Refer to instruction manual/booklet



Used indoor only

Recycling and Disposal



Disposal of equipment

In accordance with the principles, standards and requirements of the country (region) in which you are located, dispose of the old electrical equipment. Ensure that spare parts are not produced in the process of waste disposal.

After Sales

The main unit is guaranteed for 24 months from the date of purchase. The accessories (adaptor and power cord) are guaranteed for 6 months. The guarantee is valid for normal usage conditions. Any modification or accidental damage will render the guarantee void.

Malfunction and Remedy

If the equipment is not working properly, please check the following table before calling our service center.

Malfunction	Cause of Malfunction	Remedy
System malfunction	<ul style="list-style-type: none"> • Memory components malfunction • Memory components damaged 	Please contact with the seller
Over current	<ul style="list-style-type: none"> • Long time use under overload (over current) • Power cord short circuit • Motor coil short circuit 	Probably the circuit is bad connected. Please connect the motor line properly. If still no improvement, please contact with the seller.
Over voltage	<ul style="list-style-type: none"> • Main power cord broken 	Please enter the correct voltage or contact the seller.
The main unit inside overheat	<ul style="list-style-type: none"> • Due to the long time use under overload, the temperature of the main unit arise. • To use the unit under the high temperature environment (direct sunlight) 	Please wait until the temperature is cool down before using. Please place it in the environment that easy to cool down. If still no improvement, please contact with the seller.
Braking device malfunction	<ul style="list-style-type: none"> • Abnormal voltage appears the start and stop. • Start and stop circuit malfunction 	Please contact with the seller.
Motor running malfunction	<ul style="list-style-type: none"> • Malfunction of handpiece • Malfunction of motor 	Probably the chuck is opened or not fully closed. If still no improvement, please contact with the seller.

The control of start/stop

When the input pressure is greater than the preset pressure, the motor start at the currently set speed. When the motor rotates, the decimal point flashes at the end of the digital tube, and the LED light is on at the same time. When it is in the starting state and the input pressure is off, the motor stops rotating and the LED light is turned off with a set delay time off.

Press and hold the select key ⑤ ≥3s to enter or exit the manual start mode, M2 ③ M3 key ④ light flashes when prompted to enter manual start mode. In the manual start mode state, press M1 ③ or M2 ④ to start or stop the motor.

Other setting

1. Within 1 second of starting up, if the input pressure is greater than the preset pressure, the machine will prompt error E1. When the input pressure drops to zero, the equipment will return to normal.
2. After startup, if the display panel and main control platform without communication, prompt error E2, motor control is invalid.

Maintenance

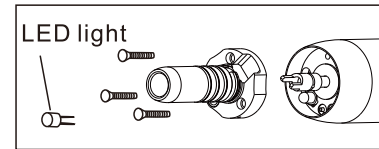

Use a screwdriver to loosen screws on the connecting shaft parts, connecting shaft was isolated, replaceable LED light.

Cleaning, Disinfection and Sterilization

Manual cleaning

- Use the softened water (< 38 °C) and brush to clean the dental electric motor.
 - a. Surface cleaning
 - b. Crevices and cavities cleaning
- Use the softened water (< 38 °C) and brush to clean the surface of dental electric motor visually clean.
 - a. Surface cleaning
 - b. Crevices and cavities cleaning
- Use the softened water (< 38 °C) and brush to brush E type connector screw, the gap part, the connection gap of the motor rear part, pay particular attention to all crevices and cavities. Repeat several times until visually clean. Then Use the water absorbent cloth to remove any remnant of liquid.

Manual disinfection

Use KaVo Cavicide disinfectant liquid to disinfect the electric motor.

Packing

NOTE:

- ▶ The quality and use of the sterilization packaging must comply with applicable standards and be suitable for the sterilization procedure!
- ▶ If potential infectious liquids and particles can contact the products, it is recommended to cover and protect these areas with sterile disposable products.

Sterilization

High temperature and high pressure sterilization is recommended. Every time after treatment, please follow the following methods to start the high temperature and high pressure sterilization. Only the motor part is available under the high temperature and high pressure sterilization.

⚠ Note: Apart from the parts that are available under the high temperature and high pressure sterilization, the other (main unit, power cord), please do not put into high temperature and high pressure sterilization.

High temperature and high pressure sterilization method

1. Please use the brush (not metal brush) to clean the attached dirt on the motor surface.
2. Please do not oil the motor.
3. Put into the bag and seal for the high temperature and high pressure sterilization.
4. The manufacturer recommends sterilization at 121 ° C for 15 minutes.
5. Screw the Motor Cap to the Motor and the protection plug to the Motor connection.

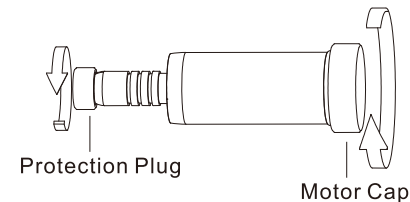

Attention for High temperature and high pressure sterilization

1. Do not oil the motor inside.
2. Motor must be unload the motor cord before sterilization.

Storage and Transportation

1. This equipment should be handled with care, and far away from the shock; and install or keep in the place where is try and cool.
2. Avoid being storage with the poisonous, corrosive, flammable, explosive products.
3. During the transportation, shock and impact should be avoided, and lift safety.